



T10Y MCA

User's Manual

Table Of Contents

CHAPTER 1	
GETTING STARTED	1
Getting Started	2
Inventory	3
Safety and Maintenance	4
Checklists	5
Features	6
Where to Look For Information.....	7
Quick Start	8
Loading Windows	9
Adjusting the Volume	10
Adjusting the Brightness	10
Turning off Your MCA.....	11
CHAPTER 2	
GETTING STARTED	12
Hardware and Software	13
Front View	14
Right View	15
Bottom View.....	16
Power Indicators	17
Buttons.....	18
Function Keys	19
Touch Pen.....	20
Disk Drives.....	20
LCD Screen	22
Touch Screen	23
Information about Fingerprint function	25
Information about Barcode scanner	26
How to use the Barcode scanner	28
Information about RFID reader	29
Information about Camera function	30
Communication Components.....	32
Information about 3G function.....	33
Information about Bluetooth function	34

CHAPTER 3	
MAKING CONNECTIONS	35
Making Connections	36
CHAPTER 4	
POWER MANAGEMENT	37
Power Management	38
When to Replace the Battery	39
Heat Considerations	40
CHAPTER 5	
DOCKING STATION CONNECTORS	41
Docking Station Connectors-Front & Left side.....	42
Docking Station Connectors-Right side.....	43
Docking Station Connectors-Top side.....	44
Mechanical Specification	45
APPENDIX A	
STATEMENTS	46
Statements.....	47
European Notice.....	48
Safety Compliance	50
Battery Disposal.....	51
CAUTION FOR ADAPTER.....	51
BATTERY CAUTION.....	51
REGULATORY INFORMATION(INTEL WIFI).....	54



Chapter 1
Introduction



Getting Started

Congratulations on your purchase of a **MCA**. The mobile clinical assistant (MCA) is a category of mobile computing platform developed by Intel® to be a new usage model that is customized for healthcare-specific use at the point of care, supporting the workflow of nurses and clinicians. This **mobile clinical assistant (MCA)** integrates technology from **Intel® Health**.

With your MCA you will be able to organize and access important clinical information anywhere, anytime. In addition, you will be able to use the biometric fingerprint reader or authenticate your badge with the RFID reader.

This Manual contains all the information you need to set up and use your MCA. It describes all the features of the MCA in an easy-to-read yet thorough manner.



The Intel® Health brand signals the company's specialization in healthcare and commitment to the healthcare industry while drawing on Intel's rich heritage as a technology innovator. Intel is a trusted name associated with innovation, reliability, quality, and speed — attributes that resonate with key decision makers in the healthcare sector.

Intel and the Intel logo are trademarks of Intel Corporation in the U.S. and other countries.

Inventory

This MCA is designed for years of productive and pleasurable computing. Use this section to keep details of your purchase. This information will be required should you need to make repairs to your MCA during the warranty period. Update this section when you add new options.

DATE OF PURCHASE: _____

PLACE OF PURCHASE: _____

DEALER'S NAME: _____

DEALER'S ADDRESS: _____

TELEPHONE: _____

E-MAIL ADDRESS/WWW: _____

CONTACT PERSON: _____

MODEL NUMBER: _____

SERIAL NUMBER: _____



Safety and Maintenance

You can use your MCA under a wide range of environmental conditions. However, to ensure long use and continued high performance, consider the following factors when setting up your MCA:

- Follow all warnings and instructions noted in this documentation and in the Windows Help program.
- The first time you use your MCA, we recommend that you carefully read the Making Connections section of this manual and initialize the battery to ensure optimum battery performance.
- Unplug the MCA from the power outlet before cleaning. Use a damp cloth for cleaning. Do not use aerosols, solvents, or strong detergents.
- Slots and openings in the system cabinet are for ventilation purposes. Do not block or cover these openings or the system could overheat. Do not use or store the MCA near a source of heat or dust.
- On the base or rear panel of this MCA, there is a label with information on the power requirements of this system. These requirements must be followed. If you are unsure of your local power supply, consult your dealer or local Power Company.
- Do not step on or place anything on the power cord.
- If you use the MCA with an extension cord, ensure that the total ampere ratings of all the devices sharing the extension do not exceed the rating of the extension cord or the rating of the wall outlet.
- Never push foreign objects into the MCA through any of the slots or openings. Dangerous voltages are present, which could cause electric shock or fire, or damage sensitive components.

Cleaning the MCA

To clean the MCA, wipe its surface gently using a soft cotton cloth slightly dampened with alcohol or disinfecting products.

The device's outer surfaces (plastic shell, seal, touch panel, buttons, docking base connector, barcode scanner window, etc) can resist (80% or less) Alcohol, bleach, iodine and common hospital disinfectants.

Checklists

After opening the package, carefully inspect the contents. If any of the items is missing or appear damaged, contact your dealer. The shipping carton should contain the following:

STANDARD

- A MCA with a hard disk drive
- Two standard batteries
- An AC adapter with power cord
(I.T.E. AC power or Medical AC power)(Option)
- User's Manual (Installed in Hard Disk)
- Driver CD (Installed in Hard Disk)

OPTIONS

The following items are normally optional, but some vendors may include them in the standard package. Some items may not be available in some countries, or some vendors may choose not to carry all the items.

- Additional battery
- 3G module
- RFID reader
- Barcode scanner
- 2 mega pixels camera module
- Docking station



Caution: When purchasing any of the accessories listed above, purchase only those accessories that are approved for use with your MCA. The above accessories are proprietary items. Your system vendor can obtain these approved accessories. If you use items that are not approved for use with this MCA, you may cause your MCA to malfunction, or to emit or receive electro-magnetic radiation in excess of local regulations. For non-proprietary accessories such as PC cards or printers, ensure that the accessory functions properly in your MCA before making the purchase. Your system vendor may be able to recommend reliable brands and models.

Features

Software Included

Windows® XP Tablet PC Edition which includes:

- Microsoft® Internet Explorer
- Microsoft® Outlook Express
- Microsoft® Windows Media Player

Windows Vista® Business (Optional)

High performance Processors

- Intel® ULV U2100 1.06GHz CPU or above (FSB 533MHz)
- Intel® ULV Celeron® 423 1.06GHz CPU or above (FSB 533MHz)

Smart Display

Automatic screen orientation & brightness adjustment

Smart Touch

Fingertip & stylus accessible, automatically timing control & palm rejection implemented

Comprehensive Network Connection

- PAN: Bluetooth 2.1
- LAN: Wireless LAN 802.11 a/b/g/n
- MAN: 3G module (optional)

Versatile Integration

RFID Reader, Barcode Scanner, Fingerprint Reader, Webcam and Microphone Array

Unburdened Consideration

Slim, light weight, no noise (fanless), and “grip & go” ergonomic handle

Rugged Enhancement

Sustainable from the free drop (3 feet height) and severe ingress level (IP54)

Flexible Battery Supply

Long power supply up to 4.5 hrs

Extended Access Control

3 user programmable keys available to define

Rugged Standard

Drop Resistant:

26 drops of 36 inches to plywood over concrete with unit on
2 units to pass.

Water Sealing:

Rain chamber to operate at no less than 40 PSIG and no less than 4
in/hr. 10 min per axis, 6 axes, Unit is non-operating.

Where to Look For Information

About Your MCA

This User's Manual describes the key elements of your MCA. New users can find a simple step-by-step orientation in the Quick Start section of this chapter.

About Windows

Windows Online Help, found on the Start menu, offers extensive Windows assistance. **Welcome to Windows** offers an online orientation for new Windows users. Find it in:

Start/Programs/Accessories/System Tools.

Quick Start

Turning on the MCA for the First Time



1. Connect the power cord to the AC/ DC adapter.
2. Connect the AC/ DC adapter to the DC power port on the right hand side of your MCA.
3. Connect the power cord to an AC outlet.
4. Press the power button to turn on the power.

AC Adaptor features:

I.T.E. AC power

Input: 100V-240V, 50Hz-60Hz

Output: 65W, 20V

Medical AC power

Input: 100V-240V, 47Hz-63Hz

Output: 78W, 18V



Note: The battery is not fully charged. Allow your battery to fully charge before using it (i.e., before disconnecting AC power). Calibrating the battery before use is also highly recommended. Refer to Chapter of *Power Management*, for further information.

Loading Windows

The following section is for installing the Windows operating system only. If you are installing a different operating system, please check with your vendor for installation details.

Your MCA will begin loading Windows once you turn on the power. Wait a few seconds for Windows setup to load. The Windows setup will prompt you for the product key number, shown to the right:



Product key number

Note: The product key is on a sticker adhered inside of the battery compartment of the MCA.

1. Type your name, and, if applicable, the name of your company.
2. Read the End User's License Agreement. Click **Next** to accept it.
3. Enter the product key number. You can find this on the Certificate of Authenticity on a sticker attached to the MCA. Click **Finish**.
4. The Start Wizard will prompt you to set the date, and your local time.

After the Start Wizard updates your system settings, the Welcome to Windows screen will appear. You may disable this feature by clearing the check box labeled **show this screen each time Windows starts**.

Some software comes preloaded with Windows. New users can familiarize themselves with this software by selecting Programs from the start menu, then clicking on programs to run them.

Adjusting the Volume

You can adjust the volume with hot key:

- Fn On + Navigation Key with pressing it upward: volume up
- Fn On + Navigation Key with pressing it downward: volume down

Alternatively, you can adjust the volume with the Windows volume control applet located on the taskbar.



Adjusting the Brightness

Use the following hot key combinations to adjust the LCD panel brightness:

- Fn On + Navigation Key toward left: decreases the brightness
- Fn On + Navigation Key toward right: increases the brightness

Turning off Your MCA

Turning off the MCA properly is important to maintaining your MCA.

1. On the Start menu, click **Shut Down**.
2. Click the radio button next to **Shut Down** in the Shut Down Windows screen, and then click **OK**.

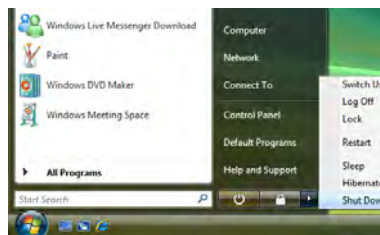

If you are going to be away from the MCA for a short period, there are ways of conserving power without shutting down the system.



Warning: Shutting off the MCA improperly may result in data loss.



Chapter 2

Getting Started





Hardware and Software

This chapter introduces the different components and controls of your MCA, including the hardware components, the software, and the audio and video systems.

Getting Started

Before you begin using your MCA, read this chapter to familiarize yourself with the main components installed in the system.

Front View

1. Tablet handle
2. RFID reader trigger
3. Barcode scanner trigger
4. Status indicator
5. Power button
6. Bluetooth On/Off button
7. Camera capture
8. Function key
9. Navigation & Enter key
10. User programmable keys
11. Security key
12. Finger printer scanner
13. Internal microphone array
14. Touch Screen panel
15. Internal RFID reader antenna

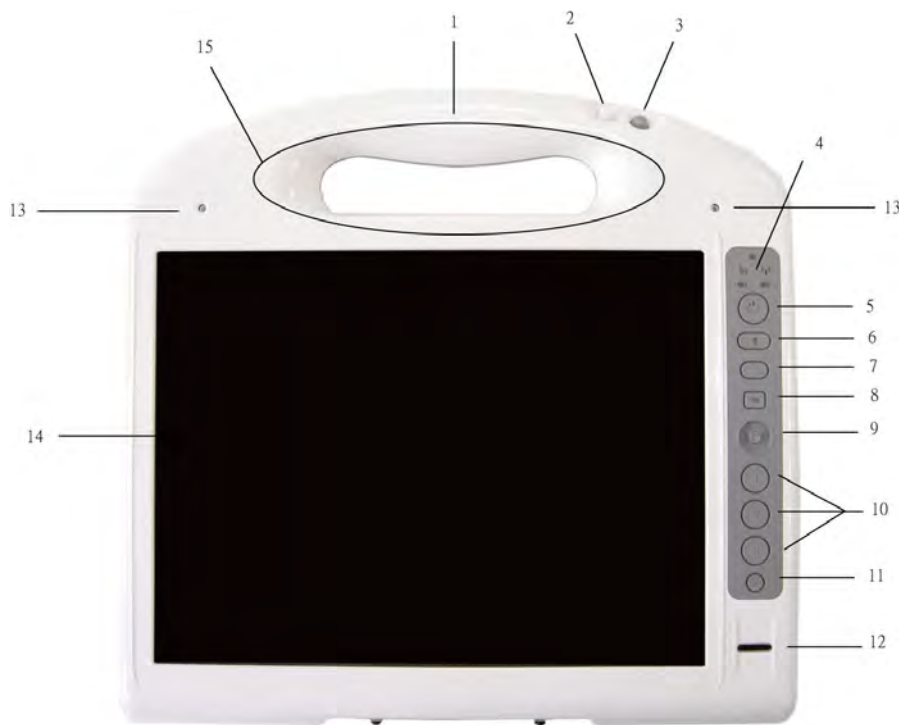

Right View

1. LCD panel
2. Barcode scanner sensor
3. DC power jack
4. Docking connector





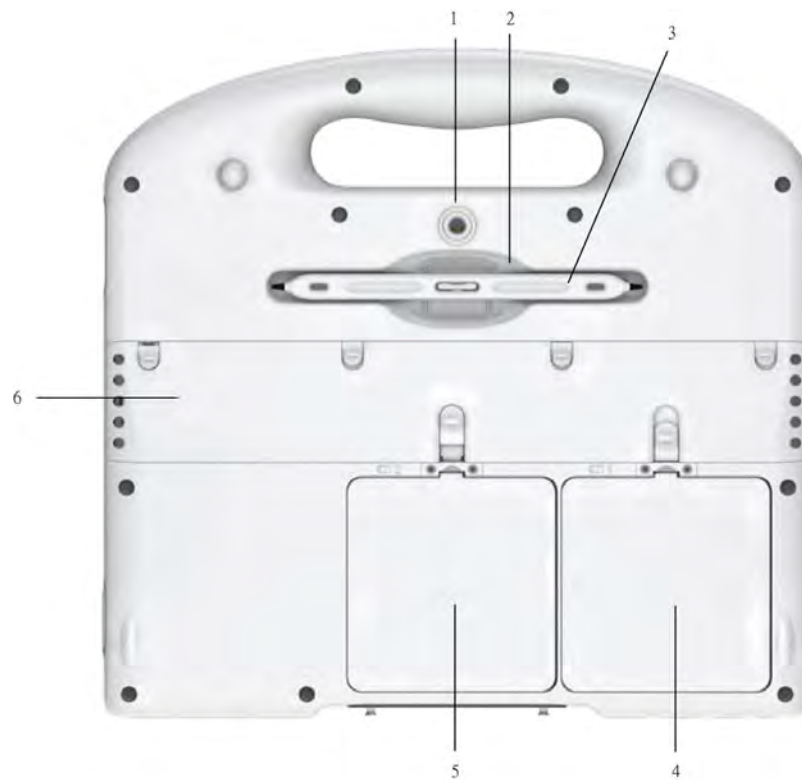

Bottom View

1. Camera lens
2. Touch pen holder
3. Touch pen
4. 1st battery
5. 2nd battery
6. Internal speaker



Power Indicators







The power indicators show which power source the system is using. They also show battery status and low battery power alerts. The power indicators remain active and viewable even when the LCD panel is closed.



Icon	Light	Description
	Blue	Wireless LAN is in use
	Green	RFID is in use
	Green	Battery fully charged
	Orange	Battery charging
	Red	When battery capacity is low than 10%
	Flashing Orange	When OTP (over temperature protection) of the battery is activated
	Green	Power is on and the battery is in use
	Flashing Green	Power is in suspend mode



Buttons

The eleven hot keys are unique features of your MCA. The function as follows:

Icon	Function
	Suspend/Power on-off button The Power button turns system on and goes into standby automatically. If the unit has been sitting unused for a while. Press momentarily to turn on the system or to exit from standby. Press and hold for at least 3-4 seconds to turn off the system. These settings can be changed.
	RFID reader trigger Through setting in Intel MCA SDK (White button on handle).
	Barcode scanner trigger (grey) Through setting in Intel MCA SDK (Grey button on handle).
	Bluetooth On/Off button Press to wakeup built-in Bluetooth module, Bluetooth module will be power down after certain time set by user if no more activities.
	Camera Capture Through setting in Intel MCA SDK
	Function Button Alternative definition for navigation, user programmable and security button.
	Navigation & Enter Key 5 ways button for Up/Down/Left/Right/Enter.

	<p>Security key Similar function as pressing Ctrl+Alt+Delete on a standard keyboard.</p>
	<p>3 user programmable keys Press to launch specific program defined by user through Intel MCA SDK (software development kit)</p>

Function Keys

Press the Fn key first and then press the function key.

Function key	Description
Fn on + Down	Volume down
Fn on + Up	Volume up
Fn on + Left	Brightness decrease
Fn on + Right	Brightness increase
Fn on + button 3	Enable/ disable the 3G module
Fn on + Security key	To lock/unlock the touchscreen manually
Fn on + Enter key	To unlock the docking station manually
<p>*User may also choose to lock the touchscreen automatically after some idle time. See page 23 for detailed setting.</p>	

Touch pen

You can use the touch pen to replace a mouse when using a MCA. Store the pen in the pen holder when not in use. To put the pen in the pen holder, press it until it clicks into place. To remove the pen, press down on one end, grab the other end, and remove from the holder.



Disk Drives

Your MCA comes with component for reading and writing (recording) information.

Hard Disk Drive

The hard disk provides high-capacity storage and fast access. Windows OS and most programs are stored here. Your MCA identifies the hard disk drive as drive C. In order to protect your precious data, this MCA features a G-sensor which "parks" the hard drive when it senses a dropping motion.

Operation instructions on the HDD protection application.

Click the HDD protection icon to launch HDD protection application.



You will see the program screen as:



“HDD protection OFF” is checked as default. If you are using default parameters, just click the “ON” tag under “HDD protection “to activate hard disk protection function.

When HDD protection is activated, there will be a pop-up window shown on the screen once a free fall or abrupt motion detected.



At this situation, all disk access requests will be blocked. Certain application may detect some error if they set timer when accessing files. But others are just waiting their disk I/O to complete. User may release the hard disk by pressing OK button. Otherwise HDD will be released automatically after some preset time period (5 seconds by default) if no more free-fall or movements is detected.

You may also find the HDD protection icon at the task bar.



When the icon shows green, it means that the HDD protection function is on. When the icon shows red, it means that the HDD protection function is off.

LCD Screen

- 10.4" XGA (1024x768) TFT LCD
- LED Backlight
- Luminance: 165 nit (minimum), 240 nit (typical)
- Contrast ratio: 120 (minimum), 250 (typical)

- **Light Sensor**

The built in ambient light sensor is to adjust the brightness of LCD. This will be performed automatically while in battery mode for saving power, and can be enabled/ disabled through setting in the BIOS.

▪ Advanced Menu

BIOS SETUP UTILITY

Main Advanced Boot Security Exit	
Advanced Setting	Options Configuration settings related to Trusted Computing innovations
▶ Trusted Computing	
ATA/IDE Configuration [Compatible] Legacy IDE Channels [PATA Only]	
Devices Configuration	
Enable Bluetooth Timeout [Enable] Bluetooth Timeout Timer [10 Mins] Enable Light Sensor [Enable]	←→ Select Screen ↑↓ Select Item + - Change Option F1 General Help F10 Save and Exit ESC Exit
V02.56 ©Copyright 1985-2004, American Megatrends, Inc.	

- **Screen Rotation**

This MCA uses G sensor to switch Landscape/Portrait mode automatically when the machine turns. It works for 0° - 90° - 180° - 270°, and can be enabled/ disabled through the [Digiheal Application software]. Default setting is enabled.

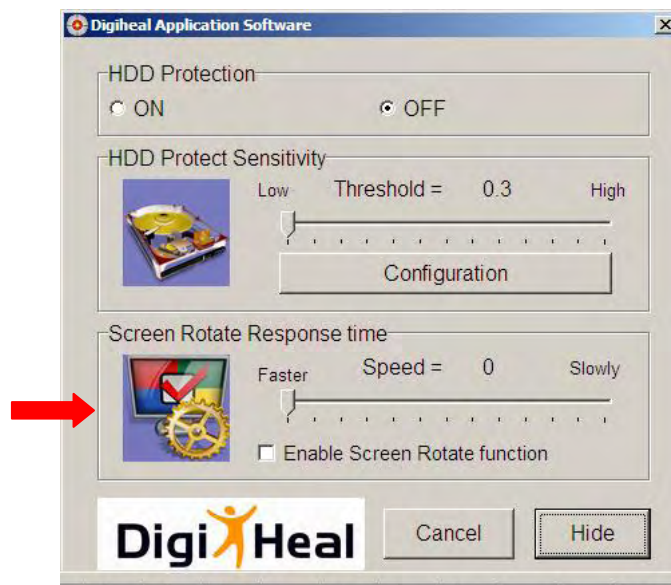

Touch Screen

- Calibration software will be provided for use by users
- Calibration and precision will be retained at least 72 hours of full time use, except for below:
 1. Frequently abnormal power the unit off
 2. Reinstall the OS on the unit
 3. Expose the unit to the environment which has great temperature difference than the one performs the calibration

- **Palm rejection**

This MCA features palm rejection function which refers to the touch screen's resistance to making the cursor jump when you inadvertently touch the screen with the palm of your hand.

- **To lock/unlock the touch screen**

To lock: 1. Manually (FN + SAS key)

2. Automatically (after some idle time presetting by user)

To unlock: Manually (FN + SAS key)

*If you want to lock the touch screen automatically, you need to follow following instruction:

(1) Double click the Touchkit icon to launch Touchkit application.



(2) Select [Setting] → [Option]

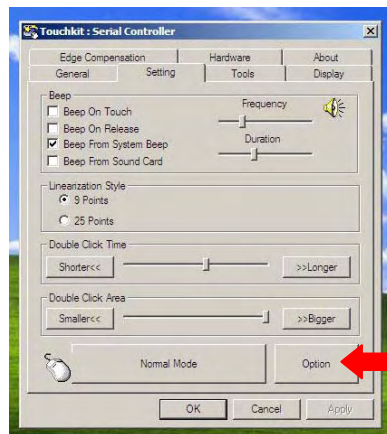

(3) You will find [Lock Touch Function Time] section on the bottom.

Select [Enable] to activate this function. You can also adjust the idle time in this section.

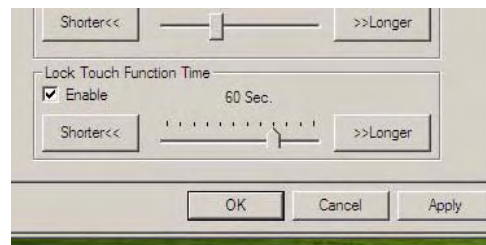

Information about Fingerprint function

With use of fingerprint authentication, you can log on to Windows by only authenticating fingerprints that have previously been registered.



With fingerprint authentication, you can omit entering a user name and a password by just sliding your finger onto the fingerprint sensor at the time of logging in homepages or logging on Windows.

Tips:

**Hold your finger and scan at the same angle each time.*

**Don't swipe too fast or too slow or it will make a capture unsuccessful.*

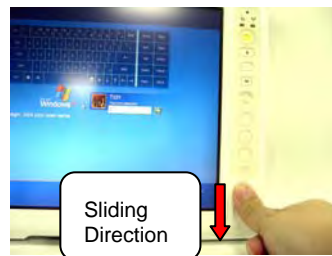

User will find an icon  on Windows task bar.

Please double click on it to execute fingerprint software.

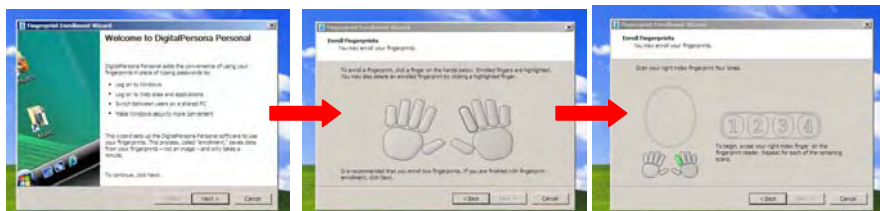

**Up to 10 sets of fingerprint data can be saved in the system. Users who use fingerprint authentication can be added and deleted.*

Information about Barcode scanner

Barcode scanner with red light scanning, supports 1D/2D barcode.

1D symbologies:

EAN/UPC, RSS, Code 39, Code 128, ISBN, ISBT, Interleaved, Matrix, Industrial and Standard 2 of 5, Codabar, Code 93/93i, Code 11, MSI, Plessey, Telepen, Postal Codes

2D symbologies:

Data Matrix, PDF417, Micro PDF 417, Maxicode, QR, Aztec, EAN, UCC composite

Reading Distances

All distances are measured from the front of a non-integrated imager using **Grade A** symbologies. An exit window reduces reading distances by about 4%.

Typical Reading Distances

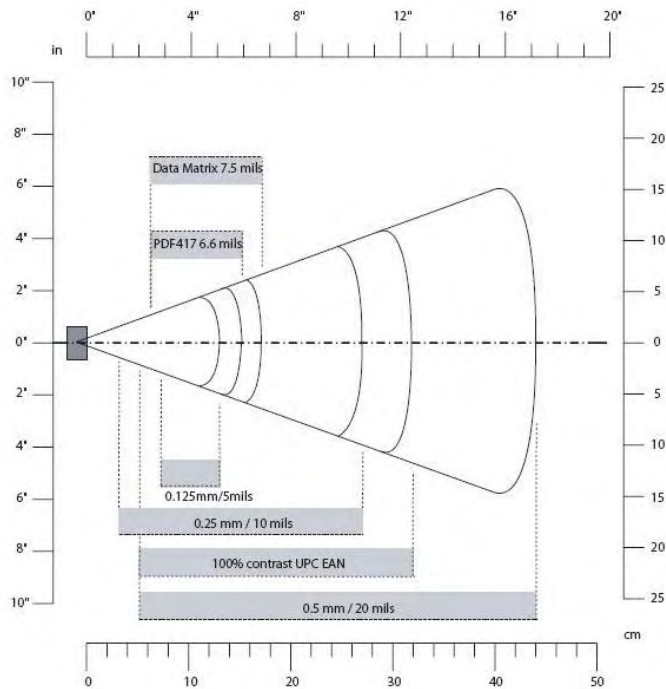

Typical Reading Distances: These distances are measured in an office environment (250 lux).

Typical Reading Distances

Symbology	Density	Minimum Distance	Maximum Distance
Code 39	0.125 mm (5 mils)	7.2 cm (2.8 in)	13.1 cm (5.1 in)
	0.20 mm (8 mils)	3.8 cm (1.5 in)	22.5 cm (8.8 in)
	0.25 mm (10 mils)	3.4 cm (1.3 in)	27 cm (10.5 in)
	0.5 mm (20 mils)	5 cm (2 in)	44 cm (17.2 in)
	1 mm (40 mils)	8 cm (3.1 in)	83 cm (32.4 in)
UPC/EAN	0.33 mm (13 mils)	5 cm (2 in)	32 cm (12.5 in)
Data Matrix	0.191 mm (7.5 mils)	6.3 cm (2.5 in)	17.3 cm (6.7 in)
	0.254 mm (10 mils)	4.8 cm (1.9 in)	22 cm (8.6 in)
	0.381 mm (15 mils)	*	29 cm (11.3 in)
PDF417	0.16 mm (6.6 mils)	6.2 cm (2.4 in)	15.4 cm (6 in)
	0.254 mm (10 mils)	4.5 cm (1.8 in)	23 cm (9 in)
	0.381 mm (15 mils)	4 cm (1.6 in)	37 cm (14.4 in)

*Minimum distance depends on symbology length and scan angle.

How to use the Barcode Scanner:

Please click on [TwMCA-App] icon shown on Desktop. Then click it to execute Barcode scanner software.



Then select [Decode ON] button on the application software to turn on built-in barcode scanner. It will be ready to read when there is a red light beam emitting from the device, and complete the reading when the light is off. To stop barcode scanner, please press [Disconnect] button..

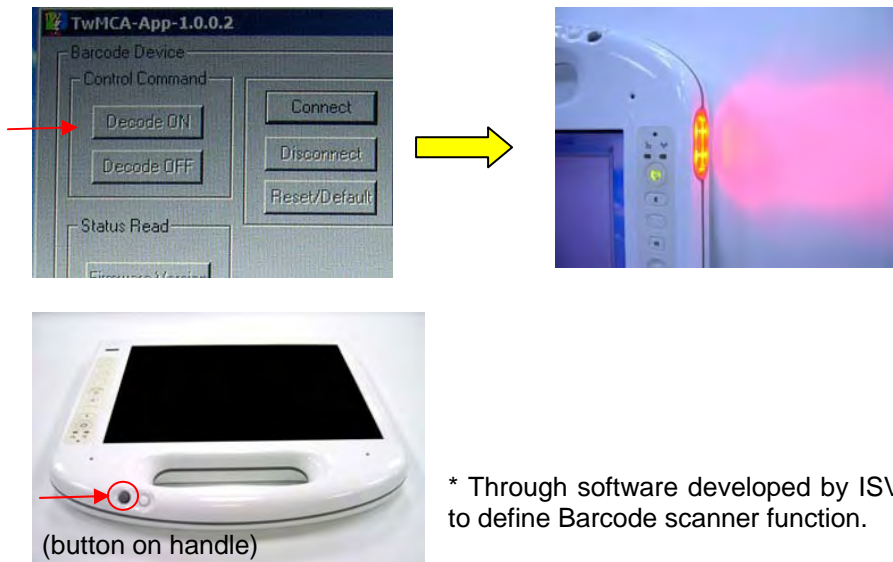

* Through software developed by ISV to define Barcode scanner function.

Information about RFID reader

The RFID reader is a compact contactless reader which supports Mifare® cards and ISO14443A & ISO 14443B & ISO15693.

How to use the RFID reader:

Please click on [TwMCA-App] program icon shown on Windows desktop to execute RFID reader software.

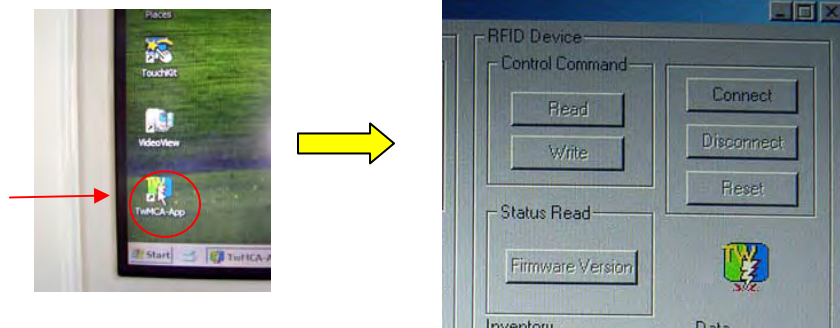

Press [Connect] button on the application software to turn on built-in RFID reader, then put RFID card on the sensor area and press [Read] button. To stop RFID reader, please press [Disconnect] button.



*Through software developed by ISV to define RFID function.

Allowable position to read the tag:

Correct position



Wrong position



The maximum reading distances for different protocol:

Protocol	Distance
ISO 15693	7cm
ISO 14443A	6cm
ISO 14443B	3cm

Information about Camera function

The camera lens is on the back of the MCA.

Features:

- 2 mega pixels resolution (1600 x 1200)





Communication Components

This system includes built-in Wireless LAN, Bluetooth and 3G functions:

Built-in Wireless Local Area Network

The built-in Wireless Local Area Network (WLAN) interface card can provide a quick access without using cables for the connection to the network equipments. The interface card adopts the IEEE 802.11 a/b/g/n protocol and uses the 2.4/5 GHz ISM electric wave frequency band as the transmission interface to set up the communications between the host computer and other computers.

The way of processing communications through the WLAN interface card is the same as that through Ethernet interface card. The “Configuration Tool” is a Window application program. If users have a computer equipped with the WLAN interface card, then users can use it to set up the interface card and show the current configuration and status.

Note: Contact your distributor for the information of upgrading the wireless local area network.

Information about 3G function

Note: The system does not support 3G Voice features.

The system provides 3G function (optional), please remove the SIM card cover. Then insert 3G SIM card into the slot.

Attention: WLAN function will be auto turn-off when 3G function is on.



Please click on [3G Watcher] program shown on Desktop to turn on 3G function.

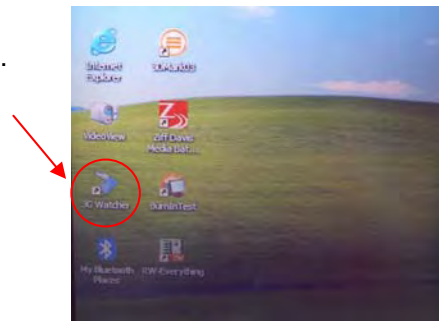

Please follow **3G Watcher Help Topics/Wireless Data Connections/Manage profiles** to create a profile first.

After all settings are completed, click Connect to access Internet.

User will find  on Windows task bar. The indicator shows the received signal strength in dBm up to a maximum of five bars..

Please click **3G Watcher Tools/Turn Radio Off** to stop connection.



Information about Bluetooth function

A Bluetooth wireless technology is the ability to simultaneously handle both data and voice transmissions. This enables users to enjoy a variety of solutions such as hands-free headset for voice calls, printing and fax capabilities, and synchronizing PDA, laptop, and mobile phone applications.

Please press  hot key to turn on Bluetooth function.

User could check Bluetooth connection status from indicator on Windows

task bar. : Bluetooth disconnection : Bluetooth connection

Double click Bluetooth indicator or  on Desktop to turn on application program.

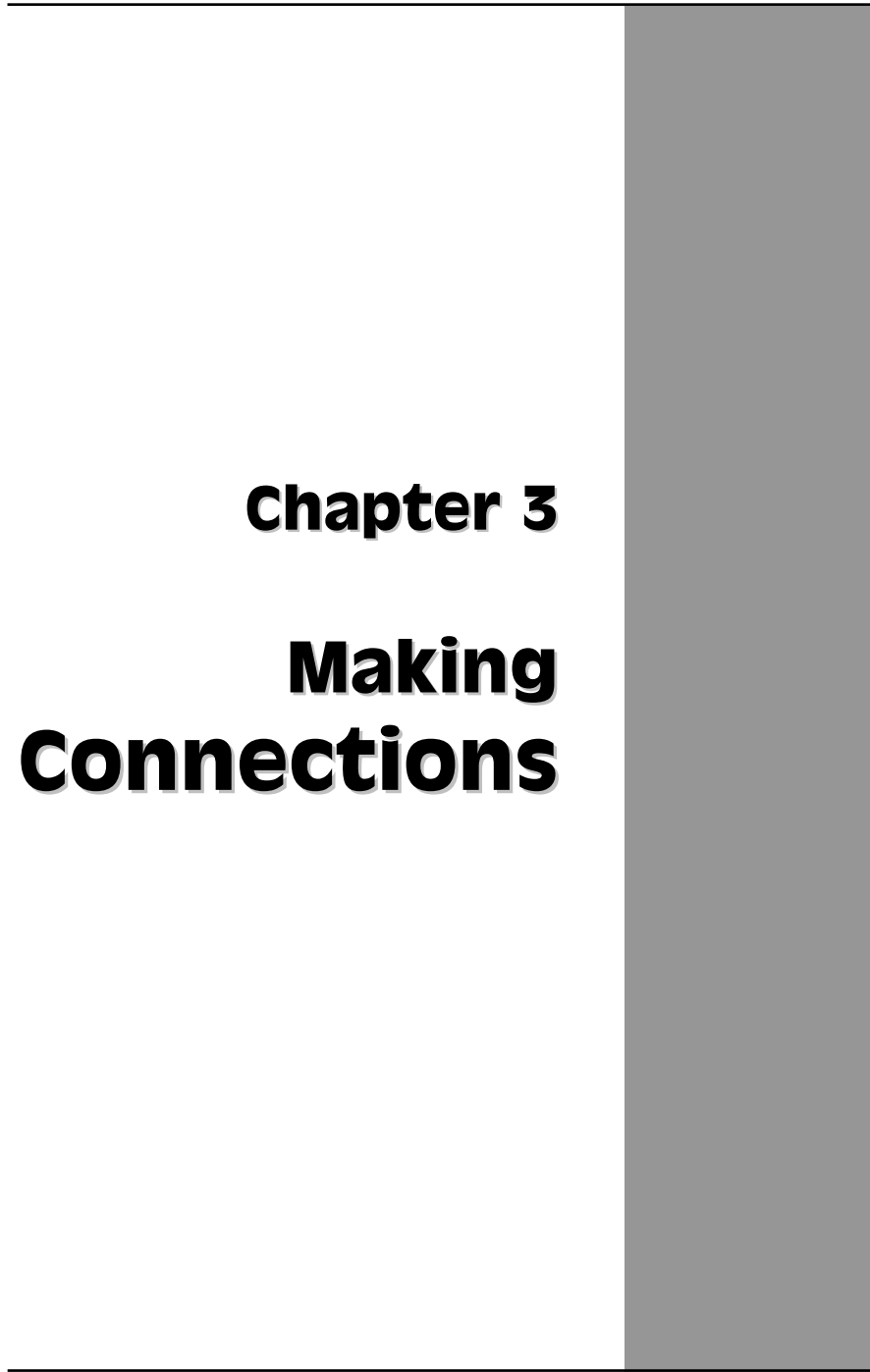

Chapter 3

Making

Connections



Making Connections

Right Side Connectors



1. DC-in Jack

Connect the power plug of the AC adapter to this jack.

2. Docking Station connector

The Connector is reserved for specific purpose which is used to connect to its docking station.



Chapter 4

**Power
Management**



Power Management

Checking the Battery Level

You can check the remaining battery power in the Windows® battery status indicator located at the lower right-hand corner of the task tray. The Battery Status icon only appears in the task tray while the unit is running on the battery power but not while the unit is running off an external power source through the AC adaptor.

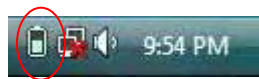

Battery Power Indicator

Enter Monitoring Battery Power

There are two ways to monitor how much power the battery has left.

1. Click Start / Settings / Control Panel / Power Options, then click Power Meter.
2. Moving the cursor to the battery icon on the taskbar is the simplest way to check on battery power status.



If you do not see the battery icon, enable it in **Start / Settings / Control Panel / Power Options**. Choose the Advanced tab and click “Always show icon on the taskbar.”

Low Battery Alarms

How your MCA responds to a low battery condition is set under **Start / Settings / Control Panel / Power Options / Alarms**.

Two different power alarms can be enabled or disabled: the Low Battery Alarm, and the Critical Battery Alarm.



Warning: When battery power is low, the battery indicator will flash red, and the alarm will display a warning on your screen. Take immediate action, such as saving files or connecting to the AC adapter, or data may be lost.

Battery Charging

When you use the AC adapter to connect your MCA to a power outlet, the internal battery will automatically begin to recharge (get charged first with battery 1, then goes to battery 2 when battery 1 is fully charged, and the MCA is powered by the AC adaptor.) While the battery is charging, the Battery Charge icon on the Indicator panel will be active after 6~12 seconds. When the battery is fully charged, the Battery Charge icon will turn off.

If your MCA is system off, a fully discharged battery will take about 2 hours to recharge. If your MCA is turned on and is not in suspend mode, it will take about 2~3 hours to recharge the battery. Refer to the following table:

	Charging
System On (Under Screen Saver Mode)	2~3 hours
System Off (suspend to RAM)	~2 hours



Note: One fully charged Li-Ion battery can run the MCA for approximately 2.25 hours.

When to Replace the Battery



Over time, the battery's capacity gradually decreases. We recommend that you replace your battery when you notice that it begins to store significantly less charge.

Changing the Battery

Change the main battery pack as follows:

1. Turn off the MCA.
2. To replace the Battery, reposition the latch and the Battery Bay Cover shown right .



- 
- 
3. Make sure the replacement battery is properly orientated. Then insert the battery into the battery compartment. Check that the latch locks back into position.

Heat Considerations

The MCA processor has been specially designed to consume little power, and generates very little heat. However, working in a hot environment, or working for long periods may raise the temperature. If the temperature continues to rise, processor activity will be reduced. You may notice a slight loss of performance when this happens.

Chapter 5

Docking Station

Connectors

Docking Station Connectors – Front & left side



1. USB (Universal Serial Bus) Ports

The Universal Serial Bus (USB) is the latest standard for attaching input devices, scanners, and other devices to a PC.

2. Kensington Slot

Kensington slot is part of an anti-theft system used as a deterrent to prevent opportunist theft. It is used for attaching a lock-and-cable apparatus.

3. LAN RJ-45 Jack

With the built-in Ethernet LAN combo, you can make LAN connections without installing PC cards. Connection speed is 10/100 Mbps.

4. LED Indicator

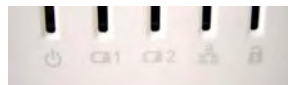

Power	Green when system is active
Battery 1 & 2	Green when battery is fully charged Orange when battery is charging
LAN	Green when the LAN is connected
Lock	Green when the locking mechanism is on

Docking Station Connectors – Right side



1. USB (Universal Serial Bus) Ports

The Universal Serial Bus (USB) is the latest standard for attaching monitors, input devices, scanners, and other devices to a PC.

2. Power Cord Entry

Connect the power cord from the AC outlet to this entry. There is a power adaptor embedded inside of the docking station (Input: 100V-240V, 47Hz-63Hz, output: 78W, 18V).

Docking Station Connectors – Top side

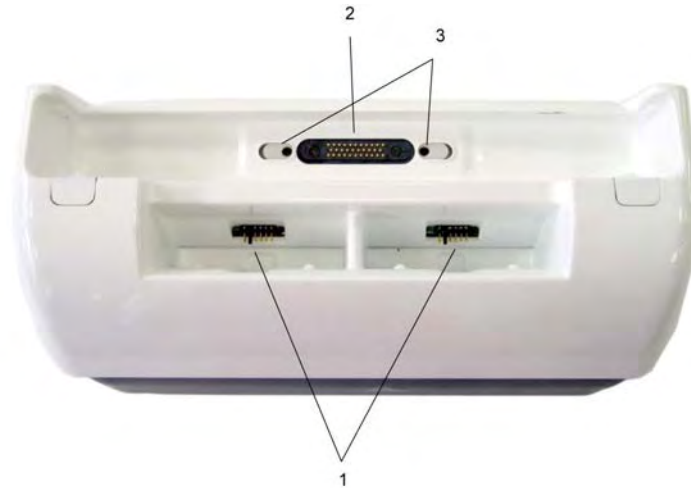

1. Battery charger

Provide 2 battery charging bays. The charging time may vary depending on system and environmental temperature.

2. Host slot

The host is used to connect to your MCA.

3. Locking mechanism

An electronic lock to keep the unit locked on the dock.



Mechanical Specification

Mounting:

An optional bracket (VESA standard, hole pattern 75 x 75 mm) is available when there is need to mount the docking station for different purposes.

Tilt:

To provide an optimal viewing performance while user is in different operating position, this docking station is capable of adjusting the tilt angle, and it ranges from 5° forwardly, and 25° backwardly.

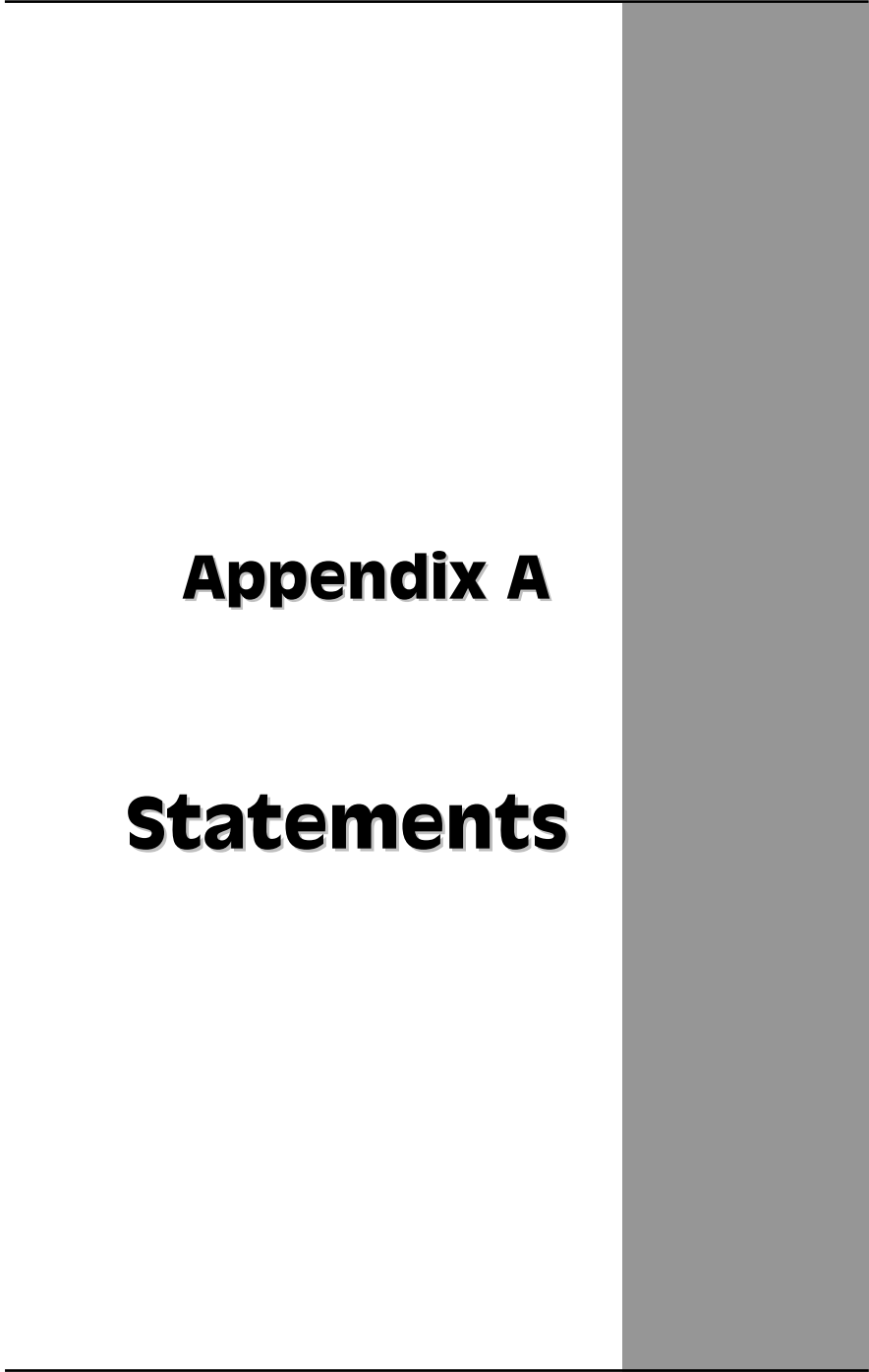

Appendix A

Statements



Statements



Federal Communications Commission Statement

This equipment has been tested and found to comply with the limits for a Class B digital device, pursuant to Part 15 of the FCC Rules. These limits are designed to provide reasonable protection against harmful interference in a residential installation. This equipment generates, uses, and can radiate radio frequency energy and, if not installed and used in accordance with the instructions, may cause harmful interference to radio communications. However, there is no guarantee that interference will not occur in a particular installation. If this equipment does cause harmful interference to radio or television reception, which can be determined by turning the equipment off and on, the user is encouraged to try to correct the interference by one or more of the following measures:

1. Reorient or relocate the receiving antenna.
2. Increase the separation between the equipment and the receiver.
3. Connect the equipment into an outlet on a circuit different from that to which the receiver is connected.
4. Consult the dealer or an experienced radio/TV technician for help.

Shielded interconnect cables and shielded AC power cable must be employed with this equipment to insure compliance with the pertinent RF emission limits governing this device. Changes or modifications not expressly approved by the system's manufacturer could void the user's authority to operate the equipment.

CAUTION

Any changes or modifications not expressly approved by the party responsible for compliance could void the user's authority to operate the equipment.

RF exposure warning

The equipment complies with FCC RF exposure limits set forth for an uncontrolled environment. The equipment must not be co-located or operating in conjunction with any other antenna or transmitter.

Declaration of Conformity

This device complies with part 15 of the FCC rules. Operation is subject to the following conditions:

- This device may not cause harmful interference
- This device must accept any interference received, including interference that may cause undesired operation.

According to FCC 15.407(e), the device is intended to operate in the frequency band of 5.15GHz to 5.25GHz under all conditions of normal operation. Normal operation of this device is restricted to indoor used environment only

European Notice



CE Declaration of Conformity

For the following equipment: Tablet built-in 802.11a/b/g/n WLAN module

Is herewith confirmed to comply with the requirements set out in the Council Directive on the Approximation of the Laws of the Member States relating to Electromagnetic Compatibility (89/336/EEC), Low-voltage Directive (73/23/EEC) and the Amendment Directive (93/68/EEC), the procedures given in European Council Directive 99/5/EC and 89/336/EEC.

The equipment was passed. The test was performed according to the following European standards:

- EN 300 328 V.1.4.1 (2003-04)

- EN 301 489-1 V.1.3.1 (2001-09) / EN 301 489-17 V.1.1.1 (2000-09)
- EN 301 893 V.1.2.2 (2003-06)
- EN 50371: 2002
- EN 60950: 2000

Standard Inspection Bureau for Japan



Authentication sign of the Standard Inspection Bureau for Japan

Standard Inspection Bureau for Korea



Authentication sign of the Standard Inspection Bureau for Korea

Standard Inspection Bureau for China



Authentication sign of the Standard Inspection Bureau for China.

Standard Inspection Bureau for Taiwan



Authentication sign of the Standard Inspection Bureau for Taiwan.

Regulatory statement (R&TTE / WLAN IEEE 802.11b & 802.11g)

European standards dictate maximum radiated transmit power of 100mW EIRP and frequency range 2.400-2.4835GHz; In France, the equipment must be restricted to the 2.4465-2.4835GHz frequency range and must be restricted to indoor use.

Safety Compliance

Safety for Canada



c-UL/CSA C22.2 No 60950-1

Safety for Korea



KETI (eK) : for adaptor only

Battery Disposal

THIS PRODUCT CONTAINS A LITHIUM-ION OR NICKEL-METAL HYDRIDE BATTERY. IT MUST BE DISPOSED OF PROPERLY. CONTACT LOCAL ENVIRONMENTAL AGENCIES FOR INFORMATION ON RECYCLING AND DISPOSAL PLANS IN YOUR AREA.

CAUTION FOR ADAPTER

THIS MCA IS FOR USE WITH MODEL NO. 0335A2065, 0335C2065, JWM180KA1800F02.

BATTERY CAUTION

DANGER OF EXPLOSION IF BATTERY IS INCORRECTLY REPLACED.

REPLACE ONLY WITH THE SAME OR EQUIVALENT TYPE RECOMMENDED BY THE MANUFACTURER. DISPOSE OF USED BATTERIES ACCORDING TO THE MANUFACTURER'S INSTRUCTIONS.

Regulatory information / Disclaimers

Installation and use of this Wireless LAN device must be in strict accordance with the instructions included in the user documentation provided with the product. Any changes or modifications (including the antennas) made to this device that are not expressly approved by the manufacturer may void the user's authority to operate the equipment. The manufacturer is not responsible for any radio or television interference caused by unauthorized modification of this device, or the substitution of the connecting cables and equipment

other than manufacturer specified. It is the responsibility of the user to correct any interference caused by such unauthorized modification, substitution or attachment. Manufacturer and its authorized resellers or distributors will assume no liability for any damage or violation of government regulations arising from failing to comply with these guidelines.

IMPORTANT NOTE (CO-LOCATION)

FCC RF Radiation Exposure Statement: This equipment complies with FCC RF radiation exposure limits set forth for an uncontrolled environment. This device and its antenna must not be co-located or operating in conjunction with any other antenna or transmitter.

Radio Frequency Interference Requirements

This device is restricted to INDOOR USE due to its operation in the 5.15 to 5.25GHz frequency range. According to FCC 15.407(e), requires this product to be used indoors for the frequency range 5.15 to 5.25GHz to reduce the potential for harmful interference to co-channel of the Mobile Satellite Systems.

High power radars are allocated as primary user of the 5.25 to 5.35GHz and 5.65 to 5.85GHz bands. These radar stations can cause interference with and / or damage this device

SAR Exposure

This device has been tested for compliance with FCC RF Exposure (SAR) limits in typical flat configurations.

In order to comply with SAR limits established in the ANSI C95.1 standards, it is recommended when using a CF card that the integrated antenna is positioned more than 1.5cm from your body or nearby persons during extended periods of operation. If the antenna is positioned less than 1.5cm from the user, it is recommended that the user limit the exposure time.

Max. SAR Measurement (1g)

802.11b: 0.150 W/kg

802.11g: 0.132 W/kg

802.11a(5.2GHz): 1.078 W/kg

802.11a(5.8GHz): 0.728 W/kg

WLAN

“To prevent radio interference to the licensed service, this device is intended to be operated indoors and away from windows to provide maximum shielding. Equipment (or its transmit antenna) that is installed outdoors is subject to licensing.”

Please note that the manufacturer must guarantee that it has no Ad-hoc capability for 5250~5350 and 5470~5725 MHz frequency band.

For LPD

“Operation is subject to the following two conditions: (1) this device may not cause interference, and (2) this device must accept any interference, including interference that may cause undesired operation of the device.”

W/detachable antenna

“To reduce potential radio interference to other users, the antenna type and its gain should be so chosen that the equivalent isotropically radiated power (EIRP) is not more than that required for successful communication.”

Regulatory Information

Intel(R) Wireless WiFi Link 4965AGN Intel(R) Wireless WiFi Link 4965AG_

[Intel\(R\) Wireless WiFi Link 4965AGN](#)
[Intel\(R\) Wireless WiFi Link 4965AG_](#)

- [Information for the User](#)
 - [Regulatory Information](#)
-

Intel(R) Wireless WiFi Link 4965AGN and Intel(R) Wireless WiFi Link 4965AG_

The information in this document applies to the following products:

Quad-mode wireless LAN adapters (802.11a/802.11b/802.11g/802.11n)
Intel(R) Wireless WiFi Link 4965AGN (model WM4965AGN)

Tri-mode wireless LAN adapters (802.11a/802.11b/802.11g)
Intel(R) Wireless WiFi Link 4965AG_ (model WM4965AG_)

NOTE: Due to the evolving state of regulations and standards in the wireless LAN field (IEEE 802.11 and similar standards), the information provided herein is subject to change. Intel Corporation assumes no responsibility for errors or omissions in this document. Nor does Intel make any commitment to update the information contained herein.

Information for the user

Safety Notices

USA—FCC and FAA

The FCC with its action in ET Docket 96-8 has adopted a safety standard for human exposure to radio frequency (RF) electromagnetic energy emitted by FCC certified equipment. The Intel(R) Wireless WiFi Link 4965AGN or Intel(R) Wireless WiFi Link 4965AG_ adapter meet the Human Exposure limits found in OET Bulletin 65, supplement C, 2001, and ANSI/IEEE C95.1, 1992. Proper operation of this radio according to the instructions found in this manual will result in exposure substantially below the FCC's recommended limits.

The following safety precautions should be observed:

- Do not touch or move antenna while the unit is transmitting or receiving.
- Do not hold any component containing the radio such that the antenna is very close or touching any exposed parts of the body, especially the face or eyes, while transmitting.
- Do not operate the radio or attempt to transmit data unless the antenna is connected; if not, the radio may be damaged.
- Use in specific environments:
 - The use of wireless devices in hazardous locations is limited by the constraints posed by the safety directors of such environments.
 - The use of wireless devices on airplanes is governed by the Federal Aviation Administration (FAA).
 - The use of wireless devices in hospitals is restricted to the limits set forth by each hospital.
- Antenna use:
 - In order to comply with FCC RF exposure limits, low gain integrated antennas should be located at a minimum distance of 20 cm (8 inches) or more from the body of all persons.
 - High-gain, wall-mount, or mast-mount antennas are designed to be professionally installed and should be located at a minimum distance of 30 cm (12 inches) or more from the body of all persons. Please contact your professional installer, VAR, or antenna manufacturer for proper installation requirements.
- Explosive Device Proximity Warning (see below)
- Antenna Warning (see below)
- Use on Aircraft Caution (see below)
- Other Wireless Devices (see below)
- Power Supply (Access Point) (see below)

Explosive Device Proximity Warning

 **Warning:** Do not operate a portable transmitter (such as a wireless network device) near unshielded blasting caps or in an explosive environment unless the device has been modified to be qualified for such use.

Antenna Warnings

⚠ Warning: To comply with the FCC and ANSI C95.1 RF exposure limits, it is recommended for the Intel(R) Wireless WiFi Link 4965AGN or Intel(R) Wireless WiFi Link 4965AG adapter installed in a desktop or portable computer, that the antenna for this device be installed so as to provide a separation distance of at least 20 cm (8 inches) from all persons and that the antenna must not be co-located or operating in conjunction with any other antenna or radio transmitter. It is recommended that the user limit exposure time if the antenna is positioned closer than 20 cm (8 inches).

⚠ Warning: Intel(R) PRO/Wireless LAN products are not designed for use with high-gain directional antennas. Use of such antennas with these products is illegal.

Use On Aircraft Caution

⚠ Caution: Regulations of the FCC and FAA prohibit airborne operation of radio-frequency wireless devices because their signals could interfere with critical aircraft instruments.

Other Wireless Devices

Safety Notices for Other Devices in the Wireless Network: See the documentation supplied with wireless Ethernet adapters or other devices in the wireless network.

Regulatory Information

FCC Radio Frequency Interference Requirements

This device is restricted to indoor use due to its operation in the 5.15 to 5.25 GHz frequency range. FCC requires this product to be used indoors for the frequency range 5.15 to 5.25 GHz to reduce the potential for harmful interference to co-channel Mobile Satellite systems. High power radars are allocated as primary users of the 5.25 to 5.35 GHz and 5.65 to 5.85 GHz bands. These radar stations can cause interference with and /or damage this device.

- This device is intended for OEM integrators only.
- This device cannot be co-located with any other transmitter.

USA—Federal Communications Commission (FCC)

This device complies with Part 15 of the FCC Rules. Operation of the device is subject to the following two conditions:

- This device may not cause harmful interference.
- This device must accept any interference that may cause undesired operation.

NOTE: The radiated output power of the Intel(R) Wireless WiFi Link 4965AGN or Intel(R) Wireless WiFi Link 4965AG_ adapter wireless network device is far below the FCC radio frequency exposure limits. Nevertheless, the Intel(R) Wireless WiFi Link 4965AGN or Intel(R) Wireless WiFi Link 4965AG_ adapter wireless device should be used in such a manner that the potential for human contact during normal operation is minimized. To avoid the possibility of exceeding the FCC radio frequency exposure limits, you should keep a distance of at least 20 cm between you (or any other person in the vicinity) and the antenna that is built into the computer.

Interference statement

This equipment has been tested and found to comply with the limits for a Class B digital device, pursuant to Part 15 of the FCC Rules. These limits are designed to provide reasonable protection against harmful interference in a residential installation. This equipment generates, uses, and can radiate radio frequency energy. If the equipment is not installed and used in accordance with the instructions, the equipment may cause harmful interference to radio communications. There is no guarantee, however, that such interference will not occur in a particular installation. If this equipment does cause harmful interference to radio or television reception (which can be determined by turning the equipment off and on), the user is encouraged to try to correct the interference by taking one or more of the following measures:

- Reorient or relocate the receiving antenna.
- Increase the distance between the equipment and the receiver.
- Connect the equipment to an outlet on a circuit different from that to which the receiver is connected.
- Consult the dealer or an experienced radio/TV technician for help.

NOTE: The Intel(R) Wireless WiFi Link 4965AGN or Intel(R) Wireless WiFi Link 4965AG_ adapter wireless network device must be installed and used in strict accordance with the manufacturer's instructions as described in the user documentation that comes with the product. Any other installation or use will violate FCC Part 15 regulations.

Underwriters Laboratories Inc. (UL) Regulatory Warning

For use in (or with) UL Listed personal computers or compatible.

Brazil

Este equipamento opera em caráter secundário, isto é, não tem direito a proteção contra interferência prejudicial, mesmo de estações do mesmo tipo, e não pode causar interferência a sistemas operando em caráter primário.

Canada—Industry Canada (IC)

This device complies with RSS210 of Industry Canada.

⚠ Caution: When using IEEE 802.11a wireless LAN, this product is restricted to indoor use due to its operation in the 5.15- to 5.25-GHz frequency range. Industry Canada requires this product to be used indoors for the frequency range of 5.15 GHz to 5.25 GHz to reduce the potential for harmful interference to co-channel mobile satellite systems. High power radar is allocated as the primary user of the 5.25- to 5.35-GHz and 5.65 to 5.85-GHz bands. These radar stations can cause interference with and/or damage to this device.

The maximum allowed antenna gain for use with this device is 6dBi in order to comply with the E.I.R.P limit for the 5.25- to 5.35 and 5.725 to 5.85GHz frequency range in point-to-point operation.

This Class B digital apparatus complies with Canadian ICES-003, Issue 4, and RSS-210, No 4 (Dec 2000) and No 5 (Nov 2001).

Cet appareil numérique de la classe B est conforme à la norme NMB-003, No. 4, et CNR-210, No 4 (Dec 2000) et No 5 (Nov 2001)..

"To prevent radio interference to the licensed service, this device is intended to be operated indoors and away from windows to provide maximum shielding. Equipment (or its transmit antenna) that is installed outdoors is subject to licensing."

« Pour empêcher que cet appareil cause du brouillage au service faisant l'objet d'une licence, il doit être utilisé à l'intérieur et devrait être placé loin des fenêtres afin de fournir un écran de blindage maximal. Si le matériel (ou son antenne d'émission) est installé à l'extérieur, il doit faire l'objet d'une licence. »

European Union

The low band 5.15 - 5.35 GHz is for indoor use only

Declaration of Conformity

The European Declaration of Conformity is posted at the following URL: http://www.intel.com/network/connectivity/resources/doc_library/regulatory/edc_4965AGN.htm.

This equipment complies with the essential requirements of the European Union directive 1999/5/EC.

•esky [Czech]	Intel(R) Corporation tímto prohlašuje, že tento Intel(R) Wireless WiFi Link 4965AGN or Intel(R) Wireless WiFi Link 4965AG_ je ve shodě se základními požadavky a dalšími příslušnými ustanoveními směrnice 1999/5/ES.
Dansk [Danish]	Undertegnede Intel(R) Corporation erklærer herved, at følgende udstyr Intel(R) Wireless WiFi Link 4965AGN or Intel(R) Wireless WiFi Link 4965AG_ overholder de væsentlige krav og øvrige relevante krav i direktiv 1999/5/EF.
Deutsch [German]	Hiermit erklärt Intel(R) Corporation, dass sich das Gerät Intel(R) Wireless WiFi Link 4965AGN or Intel(R) Wireless WiFi Link 4965AG_ in Übereinstimmung mit den grundlegenden Anforderungen und den übrigen einschlägigen Bestimmungen der Richtlinie 1999/5/EG befindet.
Esti [Estonian]	Käesolevaga kinnitab Intel(R) Corporation seadme Intel(R) Wireless WiFi Link 4965AGN or Intel(R) Wireless WiFi Link 4965AG_ vastavust direktiivi 1999/5/EÜ põhinõuetele ja nimetatud direktiivist tulenevatele teistele asjakohastele sätetele.
English	Hereby, Intel(R) Corporation, declares that this Intel(R) Wireless WiFi Link 4965AGN or Intel(R) Wireless WiFi Link 4965AG_ is in compliance with the essential requirements and other relevant provisions of Directive 1999/5/EC.
Español [Spanish]	Por medio de la presente Intel(R) Corporation declara que el Intel(R) Wireless WiFi Link 4965AGN or Intel(R) Wireless WiFi Link 4965AG_ cumple con los requisitos esenciales y cualesquiera otras disposiciones aplicables o exigibles de la Directiva 1999/5/CE.
Ελληνικά [Greek]	ΜΕ ΤΗΝ ΠΑΡΟΥΣΑ Intel(R) Corporation ΔΗΛΩΝΕΙ ΟΤΙ Intel(R) Wireless WiFi Link 4965AGN or Intel(R) Wireless WiFi Link 4965AG_ ΣΥΜΜΟΡΦΩΝΕΤΑΙ ΠΡΟΣ ΤΙΣ ΟΥΣΙΩΔΕΙΣ ΑΠΑΙΤΗΣΕΙΣ ΚΑΙ ΤΙΣ ΛΟΙΠΕΣ ΣΧΕΤΙΚΕΣ ΔΙΑΤΑΞΕΙΣ ΤΗΣ ΟΔΗΓΙΑΣ 1999/5/EK.
Français [French]	Par la présente Intel(R) Corporation déclare que l'appareil Intel(R) Wireless WiFi Link 4965AGN or Intel(R) Wireless WiFi Link 4965AG_ est conforme aux exigences essentielles et aux autres dispositions pertinentes de la directive 1999/5/CE.
Italiano [Italian]	Con la presente Intel(R) Corporation dichiara che questo Intel(R) Wireless WiFi Link 4965AGN or Intel(R) Wireless WiFi Link 4965AG_ è conforme ai requisiti essenziali ed alle altre disposizioni pertinenti stabilite dalla direttiva 1999/5/CE.
Latviski [Latvian]	Ar šo Intel(R) Corporation deklarā, ka Intel(R) Wireless WiFi Link 4965AGN or Intel(R) Wireless WiFi Link 4965AG_ atbilst Direktīvas 1999/5/EK prasībām un citiem ar to saistītiem noteikumiem.
Lietuvi [Lithuanian]	Šiuo Intel(R) Corporation deklaruoja, kad šis Intel(R) Wireless WiFi Link 4965AGN or Intel(R) Wireless WiFi Link 4965AG_ atitinka esminius reikalavimus ir kitas 1999/5/EB Direktyvos nuostatas.
Nederlands [Dutch]	Hierbij verklaart Intel(R) Corporation dat het toestel Intel(R) Wireless WiFi Link 4965AGN or Intel(R) Wireless WiFi Link 4965AG_ in overeenstemming is met de essentiële eisen en de andere relevante bepalingen van richtlijn 1999/5/EG.

Malti [Maltese]	Hawnhekk, Intel(R) Corporation, jiddikjara li dan Intel(R) Wireless WiFi Link 4965AGN or Intel(R) Wireless WiFi Link 4965AG_ jikkonforma mal- ti•ijiet essenzjali u ma provvedimenti o rajn relevanti li hemm fid-Dirrettiva 1999/5/EC.
Magyar [Hungary]	Alulírott, Intel(R) Corporation nyilatkozom, hogy a Intel(R) Wireless WiFi Link 4965AGN or Intel(R) Wireless WiFi Link 4965AG_ megfelel a vonatkozó alapvető követelményeknek és az 1999/5/EC irányelv egyéb előírásainak.
Polski [Polish]	Niniejszym, Intel(R) Corporation, o•wiadcza, •e Intel(R) Wireless WiFi Link 4965AGN or Intel(R) Wireless WiFi Link 4965AG_ jest zgodne z zasadniczymi wymaganiami oraz innymi stosownymi postanowieniami Dyrektywy 1999/5/WE.
Português [Portuguese]	Intel(R) Corporation declara que este Intel(R) Wireless WiFi Link 4965AGN or Intel(R) Wireless WiFi Link 4965AG_ está conforme com os requisitos essenciais e outras disposições da Directiva 1999/5/CE.
Slovensko [Slovenian]	Šiuo Intel(R) Corporation izjavlja, da je ta Intel(R) Wireless WiFi Link 4965AGN or Intel(R) Wireless WiFi Link 4965AG_ v skladu z bistvenimi zahtevami in ostalimi relevantnimi dolo•ili direktive 1999/5/ES.
Slovensky [Slovak]	Intel(R) Corporation týmto vyhlasuje, že Intel(R) Wireless WiFi Link 4965AGN or Intel(R) Wireless WiFi Link 4965AG_ sp••a základné požiadavky a všetky príslušné ustanovenia Smernice 1999/5/ES.
Suomi [Finnish]	Intel(R) Corporation vakuuttaa täten että Intel (R) Wireless WiFi Link 4965AGN or Intel(R) Wireless WiFi Link 4965AG_ tyyppinen laite on direktiivin 1999/5/EY oleellisten vaatimusten ja sitä koskevien direktiivin muiden ehtojen mukainen.
Svenska [Swedish]	Härmed intygar Intel(R) Corporation att denna Intel(R) Wireless WiFi Link 4965AGN or Intel(R) Wireless WiFi Link 4965AG_ står i överensstämmelse med de väsentliga egenskapskrav och övriga relevanta bestämmelser som framgår av direktiv 1999/5/EG.
Íslenska [Icelandic]	Hér með lýsir Intel(R) Corporation yfir því að Intel(R) Wireless WiFi Link 4965AGN or Intel(R) Wireless WiFi Link 4965AG_ er í samræmi við grunnkröfur og aðrar kröfur, sem gerðar eru í tilskipun 1999/5/EC.
Norsk [Norwegian]:	Intel(R) Corporation erklærer herved at utstyret Intel(R) Wireless WiFi Link 4965AGN or Intel(R) Wireless WiFi Link 4965AG_ er i samsvar med de grunnleggende krav og øvrige relevante krav i direktiv 1999/5/EF.

France

Pour la France métropolitaine

2.400 - 2.4835 GHz (Canaux 1 à 13) autorisé en usage intérieur
2.400 - 2.454 GHz (canaux 1 à 7) autorisé en usage extérieur

Pour la Guyane et la Réunion

2.400 - 2.4835 GHz (Canaux 1 à 13) autorisé en usage intérieur .

2.420 - 2.4835 GHz (canaux 5 à 13) autorisé en usage extérieur

Italy

A general authorization is requested for outdoor use in Italy

The use of these equipments is regulated by:

1. D.L.gs 1.8.2003, n. 259, article 104 (activity subject to general authorization) for outdoor use and article 105 (free use) for indoor use, in both cases for private use.
2. D.M. 28.5.03, for supply to public of RLAN access to networks and telecom services.

L'uso degli apparati è regolamentato da:

1. D.L.gs 1.8.2003, n. 259, articoli 104 (attività soggette ad autorizzazione generale) se utilizzati al di fuori del proprio fondo e 105 (libero uso) se utilizzati entro il proprio fondo, in entrambi i casi per uso private.
2. D.M. 28.5.03, per la fornitura al pubblico dell'accesso R-LAN alle reti e ai servizi di telecomunicazioni.

Latvia

A license is required for outdoor use for operation in 2.4 GHz band.

Japan

Indoor use only.

Korea

당해 무선설비는 운용 중 전파혼신 가능성이 있음

Taiwan

第十二條

經型式認證合格之低功率射頻電機，非經許可，公司、商號或使用者均不得擅自變更頻率、加大功率或變更原設計之特性及功能。

第十四條

低功率射頻電機之使用不得影響飛航安全及干擾合法通信；經發現有干擾現象時，應立即停用，並改善至無干擾時方得繼續使用。

前項合法通信，指依電信法規定作業之無線電通信。

低功率射頻電機須忍受合法通信或工業、科學及醫療用電波輻射性電機設備之干擾。

Radio Approvals

To determine whether you are allowed to use your wireless network device in a specific country, please check to see if the radio type number that is printed on the identification label of your device is listed in the manufacture OEM Regulatory Guidance document.

Regulatory Markings

A list of required regulatory markings can be found on the web at: http://www.intel.com/network/connectivity/resources/doc_library/regulatory/regulatory_markings_4965AGN.htm.
